

Data Sheet



Article number: 021816011193

Description: Clamp with bracket and rubber
SPGU 6011. 193/30 SK

Measures

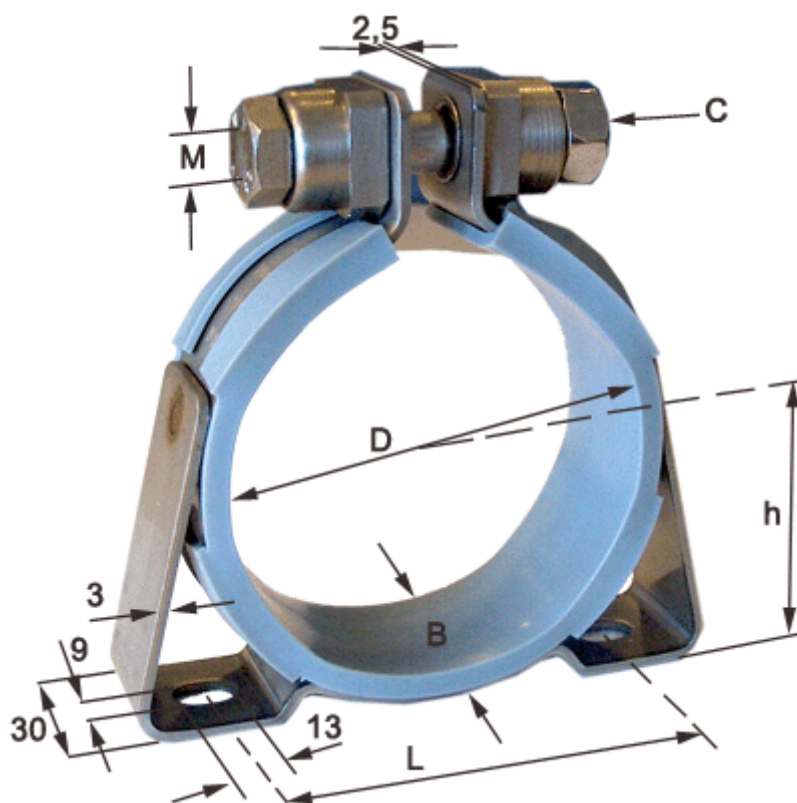

C (screw type) = SK hexagon screw

Diameter D = 193

h = 105

L = 148

Width B = 30